

TOWN OF NEW GLARUS

PARKS COMMISSION MEETING

JULY 11, 2019

AGENDA

NOTICE IS HEREBY GIVEN that Town of New Glarus Parks Commission, County of Green, will conduct a meeting for the transaction of business as is by law required permitted at such meeting as follows:

LOCATION: New Glarus Town Hall
26 5th Avenue
New Glarus, WI 53574

DATE: Thursday, July 11, 2019
TIME: 7:00 p.m.

AGENDA

- 1) Call to Order
- 2) Proof of Posting
- 3) Approve Parks Commission Minutes
 - a) 6/13/2019 Parks Meeting
- 4) Public Comments
- 5) Kim Tschudy
 - a) Shooting Park Barn Follow up
 - b) 175th Town Anniversary
 - i) Large Photo Collection & Display materials
 - ii) Coordinate Free Concert in August for 2020 Anniversary (<https://dma.wi.gov/DMA/about/ng/arng/army-band>)
- 6) Update Wilhelm Tell Shooting Park – Regarding conversations with Kevin Lague, Tell Guild and Chris Rear, Village of New Glarus Park & Recreation Director
- 7) Update on Hoesly Pond - Harry Pulliam's conversation with Dan Ziegler of FFA Alumni about potential projects
- 8) Potential Grants – Discuss for future 2020 projects
 - a) Review Budget to Date
- 9) Member Vacancy
- 10) Workshops
- 11) Adjourn

POSTED: New Glarus Town Hall 07/2/19
New Glarus Garage 7/2/19
New Glarus Post Office 7/2/19

Harry Pulliam, Chair
New Glarus Parks Commission



Pattie Salter, Clerk-Treasurer

Pursuant to applicable law, notice is hereby given that a quorum or a majority of the New Glarus Town Board or Plan Commission Members may attend this meeting. Information presented at this meeting may help form the rationale behind future actions that may be taken by the Town of New Glarus Board. Persons requiring additional services to participate in a public meeting may contact the Town Clerk for assistance at 527-2390.

OFFICE OF
Town of New Glarus
PARKS COMMISSION MEETING
THURSDAY, JUNE 13, 2019
MINUTES

ATTENDING: Harry Pulliam, Chris Narveson, Dana Emmerton, and Jason Neton

Also Attending: Kim Tschudy and Stephanie Tews

- 1) **Call to Order:** H. Pulliam called the meeting to order at 7:40 p.m.
- 2) **Proof of Posting:** P. Salter attested to proper posting.
- 3) **Approve Parks Commission Minutes**
 - a) 05/30/2019 Parks Meeting: C. Narveson moved to approve the minutes as presented. J. Neton 2nd. Motion carried.

H. Pulliam awarded Stephanie Tews the adult photo contest prize.
- 4) **Kim Tschudy:**
 - a) **Shooting Park Barn** - Kim Tschudy reported that he got the go ahead to apply for National historic preservation nomination of the barn.
 - b) 175th Anniversary – July 30-August 2
 - i. Large Photo Collection – Select Photos
 - ii. Coordinate Free Concert in August for Anniversary

Ideas for the anniversary:
Walking History Tour
Photo/video Display
Highlight Rural Heritage
Tractor Parade
Antique Tractor Pull
Parade by decade
- 5) **Potential Grants:** No action – Parks members will review the materials and discuss at the July meeting.
 - a) **Review Budget to date:** J. Neton moved to renew the Friends of the New Glarus woods subscription in the amount of \$300. D. Emmerton 2nd. Motion carried.
- 6) **Member Vacancy:** Add to website. Put an ad in the Post Messenger. Pattie will send our past recruitment article to H. Pulliam to review.
- 7) **Workshops:**
 - a) **2020 Photo Contest:** “Shadows of the Past”
- 8) **Public Comments:** Bee Club meets on June 24. Jason Neton will open the Town Hall for them. H. Pulliam will be meeting with Dan Ziegler in July. July 14 – Farmer Union Picnic.
- 9) **Schedule Next Meeting:** Next meeting scheduled for July 11 at 7 p.m.
 - a) 175th Anniversary
 - i. Review Photo and Select Images for Collages
 - ii. Coordinate free concert in August for the anniversary
 - b) Member Vacancy
 - c) 2020 Grants
- 10) **Adjourn:** D. Emmerton moved to adjourn at 9:15 p.m. J. Neton 2nd. Motion carried.



January 23, 2019

TO: Potential Grant Applicants –

- Stewardship Local Assistance grants
- Land & Water Conservation Fund grants
- Recreational Trails Program (RTP) grants

FROM: Cheryl Housley, Community Services Specialist – South Central Region

SUBJECT: Grant Applications must be postmarked May 1, 2019

The Department of Natural Resources is pleased to inform you that application materials for Stewardship Local Assistance, Land & Water Conservation Fund (LWCF), and Recreational Trails grants are available on the DNR website at <http://dnr.wi.gov/topic/stewardship/grants/applylug.html> (see application tab). The application materials are combined again this year for all three programs.

Applications must be postmarked or dropped-off no later than May 1 to be considered for funding. PLEASE clear cached data/history on your internet browser, or these new forms will not display accurately.

The following sections are somewhat different from previous years and are fillable forms:

- Section 1 & 2 (Project Information & Background): <http://dnr.wi.gov/files/PDF/forms/8700/8700-191.pdf>
- Stewardship, LWCF & Rec. Trails ranking questions (see guidance doc. pgs. 16-29 & answer template)

Guidance with ranking questions:

https://dnr.wi.gov/topic/stewardship/documents/2019_FY20_StewLUGRTALWCFAppBook_DIST.pdf

Answer Template: <http://dnr.wi.gov/files/PDF/forms/8700/8700-338.pdf>

We encourage you to obtain the application materials from our website. A limited number of paper copies are available from our office. Again this year, we ask that you submit both paper and electronic copy (CD or flash drive) of the completed application. Please provide each document as a separate electronic file, rather than one large electronic file (such as a scanned PDF of the entire application).

State Stewardship and Federal LWCF Applications. FY20 Stewardship is pending a new biennial budget year, however we anticipate that local assistance funding level will remain at \$6 million. The Federal LWCF grant funding level is unknown at this time due to the ongoing federal budget process, but applications for this program will be accepted anticipating funds will be delegated National Park Service to Wisconsin. Successful projects may be reimbursed for up to 50% of the eligible total costs. If your community is planning to acquire recreational land, develop outdoor recreation facilities, or update existing facilities to ensure accessibility, an application form is available at the above link. The application covers the state Stewardship subprograms of Acquisition and Development of Local Parks, Urban Rivers, and Urban Green Space as well as the federal LWCF grants.

If your community has a LWCF-only eligible project, i.e. active recreation such as new or renovated ballfields, splash pads, tennis courts, etc. Please prepare a LWCF-only unique application for these types of projects.

Federal Recreational Trails Applications. Recreational Trails funding will be available again this year. At this time, the funding allocation is also unknown due the ongoing federal budget process. Successful projects may be reimbursed for up to 50% of the eligible total costs. **This year, there is a maximum grant award amount of \$45,000 per project.** This program can be used as a funding match for projects in the Stewardship Program as well as the Snowmobile, ATV and UTV programs; however, separate applications must be submitted for Snowmobile and ATV grants.

A prerequisite for applying for state Stewardship or Federal LWCF grant funds is to have a current (within the last 5 years), local comprehensive outdoor recreation plan that has been adopted by your unit of government and submitted to DNR for eligibility approval. Your plan must include a specific reference to the project(s) for which you will be seeking grant assistance. If you plan to apply for grant assistance in 2019 but do not have current eligibility or are uncertain of your eligibility, please contact us to review your outdoor recreation planning needs and status as soon as possible.

If you intend to apply for grant assistance to acquire land or an easement, please contact us as soon as possible. Acquisition projects take more time to implement because appraisal and land and easement acquisition requirements must be met for your project to be eligible for grant assistance.

If your park development project involves both passive and active recreation items, you must submit two cost-estimate worksheets: one for the passive, “nature-based” Stewardship-eligible amenities and a separate one for active LWCF-eligible recreation items.

As you may be aware, **all land acquisition project applications** must now be reviewed to determine if the project will provide public access for “nature based outdoor activities” (NBOA, defined as hunting, trapping, fishing, hiking, and cross-country skiing). One or more of the NBOA activities may be prohibited or restricted **only** if necessary to protect public safety or to protect unique plant and animal communities. Because of this policy, if you are planning on submitting an application for land acquisition **it is very important that you contact us as soon as possible.**

Public demand for outdoor recreation and preservation of natural resource areas continues to grow. We encourage you to consider applying for matching grant assistance in 2019 and look forward to our ongoing partnership to provide quality outdoor recreation opportunities in Wisconsin. This may be a great opportunity for you to address a local priority outdoor recreation need at a reduced cost to your residents.

Please Remember: **This year’s application deadline postmark deadline is Wednesday, May 1, 2019.** If you have questions or need assistance, do not hesitate to contact us before the postmark deadline about potential grant projects at:

Phone number: (608)275-3218

E-mail: cheryl.housley@wisconsin.gov

If you are interested in other available grant programs administered by the Wisconsin Department of Natural Resources, please access our Community Financial Assistance web site at <http://dnr.wi.gov/Aid/>. We look forward to hearing from you and continuing the terrific accomplishments we’ve made together in conservation and outdoor recreation!

NOTE: **Mail your completed application to:**

**Cheryl Housley
Wisconsin Department of Natural Resources
3911 Fish Hatchery Rd
Fitchburg, WI 53711**

Tree Sale Planning Checklist

PRE-GAME: WORKSHOP TIMELINE

October Parks Meeting - Invite Scouts & Volunteers

- Select Tree Species
- Determine Tree Prices
- Set Order Due Date
- Set Sale Date

7 weeks

- Set the budget
- Choose the venue
- Create the guest list
- Create invitations & get quote from Postal Connections ()
- Create Facebook Post ()
- Create Website Post ()
- Create Eventbrite Event for Registration ()

6 weeks

- Finalize the guest list
- Reserve the location & discuss any special arrangements: parking, seating, audio/visual equipment, menu ()
- Start planning your opening & closing remarks ()

5 weeks

- Mail invitations (include directions & parking instructions); ask for a 2-week RSVP ()
- Email board and committee members invitation ()

4 weeks

- Check-in with Speakers - Is everything coming along ok? Are there any special needs? ()

3 weeks

- Begin follow-up calls or emails to invitees who haven't responded ()

2 weeks

- Confirm all arrangements with the venue (food, seating, parking, special equipment ()

1 week

- Post reminder on Social Media and Website
- Ensure you have all the material you need for that day: handouts, business cards, name tags, sign-in sheet and thank-you gifts/honorariums ()

DAY OF THE EVENT

- Arrive at least an hour early to set up and familiarize yourself with the venue. ()
- Greet everyone as they arrive; name tag and sign-in ()

POST-GAME: FOLLOW-UP

After the event

- Send a personalized thank-you note to Speaker ()
- Review/Critique Event
- Send Re-cap to Post Messenger

Shopping List

1-3 Days before event

- Snacks
- Plates, utensils, etc.
-
-
-
-
-
-
-
-
-



2019 1st Place Photograph by Noah Dahlsing

2020 PHOTO CONTEST

SHADOWS OF THE PAST

2020 Town of New Glarus Parks Commission Photo Contest

The Town of New Glarus Parks Commission is excited to announce this year's photo contest "Shadows of the Past"

Deadline to turn in a digital file and printed 8" x 10" photo is May 4, 2020. Submissions can be dropped off at the Town of New Glarus anytime between now and May 4, 2020.

- Details on Back -

**Help Bring Farm
Life in Green
County into Focus!**

Great Prizes!

Students 6th-12th

1st Prize \$200

2nd Prize \$100

3rd Prize \$50

Adults

One Prize \$300

**Entries Due
by May 4,
2020!**

TOWN OF NEW GLARUS

26 5th Avenue – PO Box 448
New Glarus, WI 53574

608/527-2390

<http://townofnewglarus.com>

July 1, 2019 - May 4, 2020

TOWN OF NEW GLARUS PARKS COMMISSION

PHOTO CONTEST RULES

- Amateurs only. No professional photographers may enter – your photo is not eligible if you've ever been paid for a photo. (*Previous Town of New Glarus photo contest winners do not count as professional photographers.*)
- One Entry per person
- Pictures will be judged according to two age groups: Children in grades 6-12 and adults.
- Photos must be labeled on the back with the photographer's name, age, and contact information, and the **address or fire number of the property**.
- Photographs must have been taken within the last 12 months.
- Photos must be of farmers, animals, antique machinery or buildings located in Green County.
- Photos must be 300 DPI or larger and/or be able to be printed in clear 11" x 14" format.

Additional Notes:

- We'd suggest that the structures have a historical aspect to them.
- Natural is better, but editing is allowed.
- Students: First prize \$200, second \$100 third \$50. Adults \$300.

Deadline to turn in a digital file and printed 8x10 photo is May 4, 2020.

Alison Winters Hanson will be collecting entries at the New Glarus High School. (You can also turn in photos and files to the Town of New Glarus any time prior to this date.)

The Town of New Glarus reserves the right to retain and use original photos.

All entries will be featured on a collage used by the Town.

South Central WFU, Soil Sisters & Green County Women in Sustainable Ag 2019 Summer Celebration

Sun. July 14 | 4 PM Potluck

Roberta & Kim Barham
Barham Gardens
275 County Road K,
Blanchardville, WI

Please Bring:

Dish to Pass - Beverage to
Share - Dishware- Chair
No RSVP Needed

Questions? Roberta Barham
robertabarham@gmail.com

All welcome! Tour the Barham's aronia
growing fields and their cordwood
masonry house, a 13-year sustainability
building project recently completed!



South Central
Farmers Union
UNITED TO GROW FAMILY AGRICULTURE

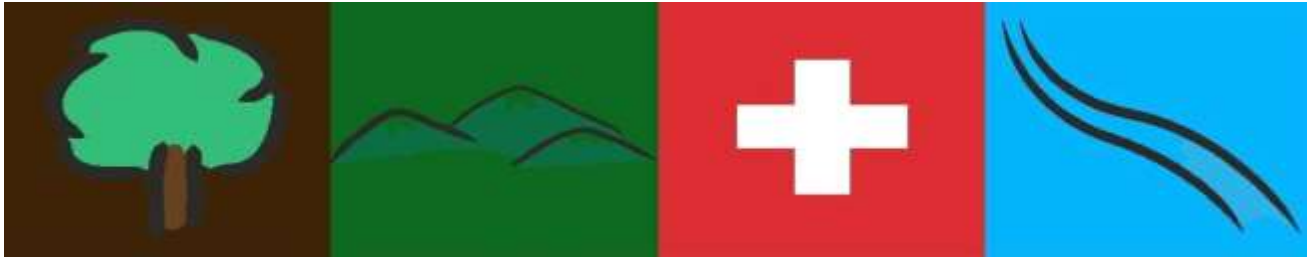

Calling all New Glarus Town Residents! Get Paid to Help us shape our recreational and open spaces.

Work with a team to decide what your Town looks like and all that it offers for recreational opportunities. The Town’s Park Commission formed in July of 2004 with the mission to “assure the needs and desires for recreational opportunities and preservation of natural areas are met.” Our committee members meet for two hours a month and are paid \$35 for every meeting they attend.

The Commission has worked on the following projects and more:

- * Organizes annual Spring Tree Sale, (pre-orders and day of sales.) Proceeds help Boy and Girl Scouts pay for trips they otherwise might not be able to afford.
- * Engages in ongoing planning for recreational walking/skiing/biking trails.
- * Established and continues to maintain the Blue Bird Ridge Conservancy, a 4-acre green space at the top of Windmill Ridge.
 - o Performs ongoing work, including controlled burns, reseeding, clearing of invasive brush and trees, installation of Bluebird houses and signs.
 - o Together with the Boy Scouts, installed bird blinds.
- * Implemented needs-based Village of New Glarus Pool Scholarship Program.
- * Hosts annual workshops. Some of these have been: Bees and Beginning Beekeeping, Barn Preservation, Controlling Invasive Species, Bird Watching and Bats.
- * Continually updates the Parks Plan and Trout Stream Map.
- * Provides Arbor Day tree planting financial support and helping hands to the Village Forester.
- * Holds semi-annual joint meetings with the Village of New Glarus Parks Committee

With all those accomplishments already, what is this group planning for the future? The commission would like to build its membership in 2019. If you reside in the Town of New Glarus please contact the Clerk-Treasurer, Pattie Salter, 608-527-2390 or psalter@townofnewglarus.com or Chair, Harry Pulliam, 527-3325 to find out more. The commission meets the third Wednesday of the month at 7:00 pm at the Town Hall 26 5th Avenue.

<p style="text-align: center;">2019 Invasive Species Workshop</p>	<p style="text-align: center;">2019 Bee Workshop</p>	<p style="text-align: center;">2019 Student Photo Contest</p>

New Glarus FFA Alumni Hoesly Pond Project 8/1/11

Our Vision at this time is a community park that people could enjoy a pond, fishing and the general beauty of the area. We envision a shelter with picnic table and benches and a stocked fishing pond.

The New Glarus FFA Alumni began the process for this project with discussions with the Village Board in 2008, with their approval we applied for the permits from the DNR and as of July 4, 2011 (Independence Day) we started the process of draining the pond for dredging. Draining then dredging is the first steps in bringing the spring fed pond back to life.

This proposal was put together with the information available at this time on where the Pond Project is going. We realize that actual costs may vary and project needs and obstacles may occur, but this is what we believe to be our needs at this time. The items on the list are our wish list for this project over time; we realize that this is dependent on permits and funding. We believe we have the support of the community and are hoping that people and businesses will assist us in making this project a reality. We have our own fundraising opportunities but will also be looking for assistance from others.

Thank You for any help that you can provide. Any questions please feel free to contact:

Bret Hoesly-608-214-1546

New Glarus FFA Alumni President

Dan Ziegler-608-235-8455

New Glarus High School Agriculture Instructor

New Glarus FFA Alumni Secretary

Ed Wettach-608-558-5835

New Glarus FFA Alumni Member

New Glarus FFA Alumni

Proposed Budget—8/1/11

Draining of Pond-----	\$2,000
Dredging-----	\$7,000
Culvert-----	\$2,600
Culvert end that has flow control-----	\$1,000
RipRap for Pond-----	\$5,000
RipRap for north end marsh protection-----	\$7,000
Windmill Aerator-----	\$2,000
Hauling Dirt away-----	\$4,000
Landscaping-----	\$5,000
Fencing-----	\$1,500
Shelter-----	\$8,000
Picnic tables/Benches-----	\$3,000
Donor Recognition plaque/sign/Bricks/?????-----	\$????

Total estimate as of 8/1/11-----\$48,100

Actual Expenses/estimates as of 11/1/11

Draining of Pond-----	\$2,410.80
Dredging-----	\$11,718.50
Culvert-----	\$1136.80
Culvert end that has flow control-----	\$1145.60
RipRap for Pond-----	\$3609.75
RipRap for north end marsh protection-----	\$7,000
Windmill Aerator-----	\$2,000
Hauling Dirt away-----	\$4,000
Landscaping-----	\$5,000
Fencing-----	\$1,500
Shelter-----	\$8,000
Picnic tables/Benches-----	\$3,000
Donor Recognition plaque/sign/Bricks/?????-----	\$????

Total/estimate as of 10/17/11-----\$50521.45



DOCKBLOCKS™
of North America

Floating Dock Proposal



Valid Until: 12/30/2017
Quote Number : 10251

Prepared For:

Jeremy Duerst
jerduerst@gmail.com
(608) 279-2450

Prepared By:

Dock Blocks of North America
Mike Eastman
mikeeastman@dock-blocks.com
(843) 471-9071



DOCKBLOCKS™
of North America



★★★★
**LIMITED
LIFETIME
WARRANTY**
★★★★

THE BEST VALUE IN THE MARKET

Nothing else stands up
to Dock Blocks®



DOCKBLOCKS



Other Modular Systems



Other Floating
Dock Systems



Copyright 2017 Dock Blocks - All Rights Reserved

1-877-478-8440
Dock-Blocks.com



THOUSANDS OF SATISFIED CUSTOMERS



“

The Dock Blocks were exactly as advertised and my family and I really enjoyed them this past summer as they replaced our permanent dock that often shifted with the freezing temps in winter.

-Jeff L., Sandy Creek, NY

”

“

We love our dock blocks boat lift! It rode out the hurricane with NO problems and currently is home to our 17 Montauk Whaler. Thinking about adding a second one in the spring!

-F. Hassell, Folly Beach, SC

”



ALL NECESSARY MATERIALS INCLUDED

FULL FLOATERS



HALF FLOATERS



TOOL KIT



CONNECTING PINS



STRENGTHENING BARS



NUTS



BOLTS



PLUGS



ADDITIONAL ACCESSORIES AVAILABLE

KAYAK RACK +
KAYAK HANDRAILS



\$720 + \$450

HANDRAILS



\$30

CLEATS



\$50

REVERSE
WINCH



\$850

SWIM LADDER



\$625



**Dimensions: x
0 Square Foot Dock**

Price per block includes all necessary connecting pins, strengthening bars, nuts & bolts. Accessories Sold Separately.

Product Details	Qty	Sale Price	Total
Full Floaters Grey (DB-002)	144	\$85.00	\$12,240.00
Assembly Tools (DB-022)	1	\$150.00	\$150.00
Assembly tools			
Freight	1	\$1,600.00	\$1,600.00
Hand Rails (DB-021)	30	\$30.00	\$900.00
			Sub Total: \$14,890.00
			Tax: \$0.00
			Grand Total: \$14,890.00

60 Day Money Back Guarantee

If the customer is not 100% satisfied with their order, the order may be returned at their expense. Pictures verifying the dock was assembled and a detailed description of the problem must be provided to DBNA to qualify. The docking system cannot have been used for any commercial purpose or special events. This is not a loaner program and will not qualify as such. Once the dock has been inspected and all undamaged parts have been returned, a check will be issued within 30 days or less for all returned undamaged components. This limited-time promotional offer is not a modification of the DBNA warranty.

Drawing of your Dock

See a draft drawing of what your dock could look like in the supplement to this proposal. Drawings are rough estimates of how your dock could look but are not part of this proposal. Final assembly is made at the discretion of the customer.

SC Carolina Residents are subject to SC Sales Tax.

Customers located out-of-state are responsible for paying their state's tax requirements. Please consult your local taxing authority for more information.

Confirming Your Order

To place your order; call, text, or email me the proceeding sales agreement. 50% deposit is due to lock in pricing. Pricing is subject to change upon expiration of this quote. Full payment is due before delivery is booked.

Sales Agreement

Dock Blocks of North America, LLC (DBNA) is the licensed manufacturer and authorized distributor of the Dock Blocks by Pier Plas product line. This contract is entered into between DBNA and the customer below:

Name: _____

Address: _____

Phone: _____

Email: _____

Purchase amount: _____

The customer agrees to the terms and conditions of the sale included in the proposal as well as the following:

- DBNA is not liable for any misuse of the product or injury that may occur due to the negligence or intentional misuse of purchaser, an invitee, or other individuals or entities not a party to this contract.
- DBNA is not responsible for maintenance of your product or permitting requirements.
- DBNA does not install and is not liable for installation.
- DBNA is not responsible for collecting or remitting sales tax on this sale unless delivery or pick-up takes place in South Carolina. Please be advised, you may be responsible for remitting use tax if you are the end-user of this product. Please consult with your tax advisor on compliance with the regulations required by the taxing authorities within your jurisdiction(s)."
- DBNA is not responsible for inaccuracies in measurements of docking system or boat specifications. Blocks may conform to the shape of heavier boats in places where additional weight is added.

Signed

Date

Please return to: Dock Blocks of North America, LLC 2851 Industrial Ave. North Charleston, SC 29405
1-877-478-8440 Phone
(206) 888-4007 Fax
sales@dock-blocks.com

LIFETIME LIMITED WARRANTY AND LIMITED LIABILITY

Dock Blocks of North America, LLC ("DBNA") warrants its product (individual flotation unit and related accessories), if not altered by the original purchaser or any third party and if used in compliance with all applicable instructions, supplements and assembly or installation videos, and if used in accordance with the DBNA users manual and applicable law, to be free from defects in material and workmanship for as long as the original purchaser owns the product and the product is used for non-commercial personal use. If the product should prove defective in material or workmanship within that period, DBNA or its contractors will, at the sole discretion of DBNA, repair or replace a defective individual flotation unit or related component part with a new or reconditioned unit or part. Service under this Warranty may be obtained by notifying a DBNA contractor or dealer of a warranty claim, which claim will then be evaluated for validity within 20 days. Call your DBNA dealer or DBNA Customer Service at 1-877-478-8440 to receive a Warranty Claim Verification Number (WCVN) prior to claim evaluation and any potential repair or replacement. DBNA warrants its product which are used for commercial purposes, if not altered by the original purchaser or any third party and if used in compliance with all applicable instructions, supplements and assembly or installation videos, and if used in accordance with the DBNA users manual and applicable law, to be free from defects in material and workmanship for five (5) years from the date of purchase and subject to the above-described claims process and individual unit repair or place policy.

THIS WARRANTY DOES NOT APPLY TO NORMAL WEAR OR TO DAMAGE RESULTING FROM ACCIDENT, MISUSE, ALTERATION, MODIFICATION, ABUSE OR NEGLECT. THIS WARRANTY EXTENDS ONLY TO THE ORIGINAL PURCHASER OF A DBNA PRODUCT. DBNA MAKES NO EXPRESS WARRANTIES OTHER THAN THE WARRANTY EXPRESSLY SET FORTH HEREIN AND A DBNA DEALER OR AGENT HAS NO AUTHORITY TO EXTEND A GREATER OR DIFFERENT WARRANTY ON BEHALF OF DBNA. EXCEPT TO THE EXTENT PROHIBITED BY LAW, ALL OTHER WARRANTIES, WHETHER EXPRESS, IMPLIED OR STATUTORY, IF ANY, INCLUDING BUT NOT LIMITED TO THE WARRANTIES AND/OR CONDITIONS OF MERCHANTABILITY, OF SATISFACTORY QUALITY, OR FITNESS FOR A PARTICULAR PURPOSE, ARE SPECIFICALLY DISCLAIMED THIS WARRANTY APPLIES ONLY TO DBNA PRODUCT PURCHASED THROUGH AN APPROVED DBNA DEALER OR SALES CONTRACTOR.

LIMITATION OF LIABILITY, REMEDIES AND DAMAGES. IN NO EVENT SHALL DBNA BE LIABLE FOR ANY SPECIAL, INDIRECT, INCIDENTAL, OR CONSEQUENTIAL DAMAGES RESULTING FROM THE USE, OR INABILITY TO USE, THE PRODUCT OR ACCESSORIES OR ARISING OUT OF ANY OTHER CIRCUMSTANCES ASSOCIATED WITH THE SALE OF THE PRODUCT, INCLUDING WITHOUT LIMITATION DAMAGES BASED ON LOSS OF PROFIT, LOSS OR INTERRUPTION BUSINESS, LOSS OF TIME, INCONVENIENCE, DAMAGE TO THE PRODUCT, PERSONAL INJURY, DEATH, OR DAMAGE TO PERSONAL OR REAL PROPERTY, OR DAMAGES RESULTING FROM MISUSE OR MODIFICATION OF YOUR DBNA FLOTATION UNIT, EVEN IF DBNA IS ADVISED IN ADVANCE OF THE POSSIBILITY OF ANY ABOVE-DESCRIBED DAMAGES. DBNA's total liability, if any, under any provision of this Warranty for any and all claims, losses or damage relating to the product or arising out of any other circumstances associated with the sale or use of a product (whether based on tort, contract, or any other theory), other than claims based upon the gross negligence or willful misconduct of DBNA, shall be limited to the amount actually paid to DBNA for the product. DBNA is not responsible for unauthorized or unlawful acts of its dealers or agents.

LAW OF SOUTH CAROLINA CONTROLS. The Purchaser and DBNA hereto agree that by in entering into this Agreement they have contracted with reference to, and adopted, the laws of the State of South Carolina and the construction and interpretation of the terms and provisions of this Agreement and the rights and obligations of the parties hereunder shall be interpreted and construed under and pursuant to the laws of the State of South Carolina, except in such cases and to such extent as the laws of another jurisdiction must control. By execution or approval of the Sales Agreement, Purchaser, DBNA, its Agents and Dealers specifically agree to be subject to personal jurisdiction in the State of South Carolina and agree that Charleston County is the designated venue for resolution of any claims or proceedings.

F H E

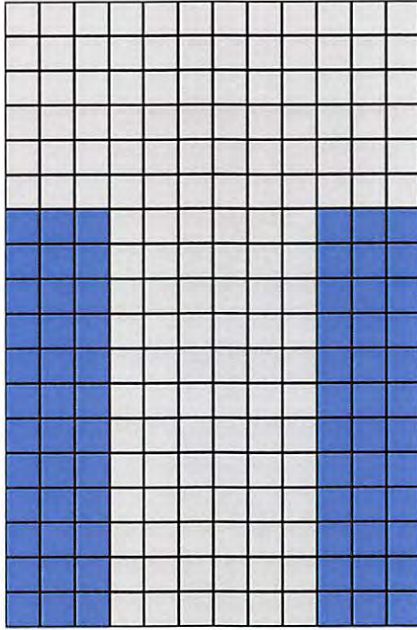

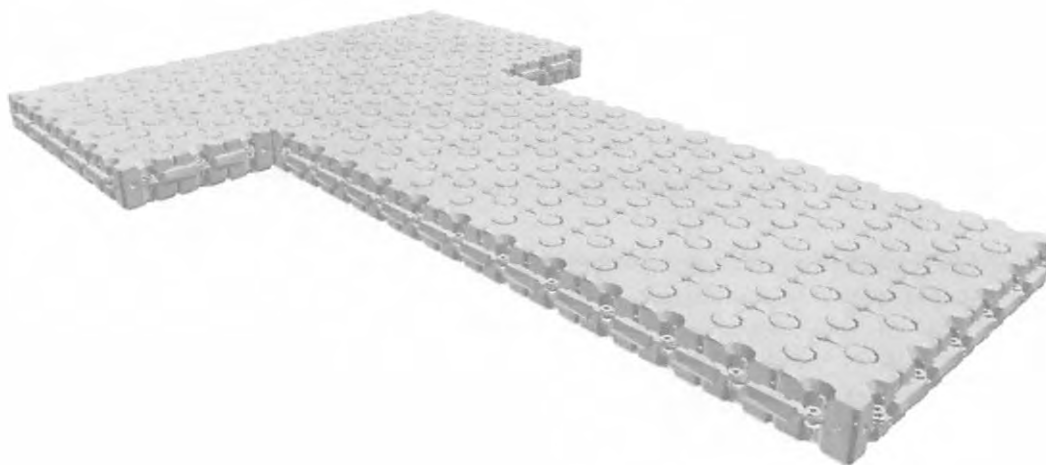

Dock Dimensions			
	Width	Length	Area
Feet	20.00	30.00	400.00
Blocks	12	18	144

Dock Parts				
	Amount	Part Price	Price per Part	Total Price
Full Floaters	144	115.00	16560.00	16560.00
Half Floaters	0	115.00	0.00	
Strengthening Bars	52	0.00	0.00	
Bow Guides	0	0.00	0.00	
Full Pins	258	0.00	0.00	
Half Pins	0	0.00	0.00	
Nuts and Bolts	60	0.00	0.00	
Plugs	144	0.00	0.00	

Dock Accessories				
	Amount	Part Price	Price per Part	Total Price
Handrails	30	30.00	900.00	900.00
Cleats	0	50.00	0.00	
Swim Ladders	0	625.00	0.00	
Kayak Rails	0	300.00	0.00	
Kayak Racks	0	725.00	0.00	
Reverse Winches	0	850.00	0.00	
Boat Boosts	0	2950.00	0.00	
Beams	0	250.00	0.00	
Decking (sqft)	0	35.00	0.00	

Grand Total	17460.00
--------------------	-----------------

New Glarus

Presented By

Commercial Recreation Specialist

and



TOP VIEW

ADA ACCESSIBILITY GUIDELINE - ADAAG CONFORMANCE

ELEVATED	ACCESSIBLE	RAMP ACCESSIBLE	GROUND	TYPES
9	9/5	0	4/3	3/3

R5

FOR KIDS
AGES
2-12

GENERAL NOTES:

This conceptual plan is based on information provided prior to construction. Detailed site information, including the following, should be obtained, evaluated, and utilized in the final project design. Exact site dimensions, topography, existing utilities, soil conditions and drainage solutions.

WARNING: Accessible safety surfacing material is required beneath and around this equipment that has a critical height value (Fall Height) appropriate for the highest accessible part of this equipment. Refer to the CPSC'S Handbook For Public Playground Safety, Section 4: Surfacing.

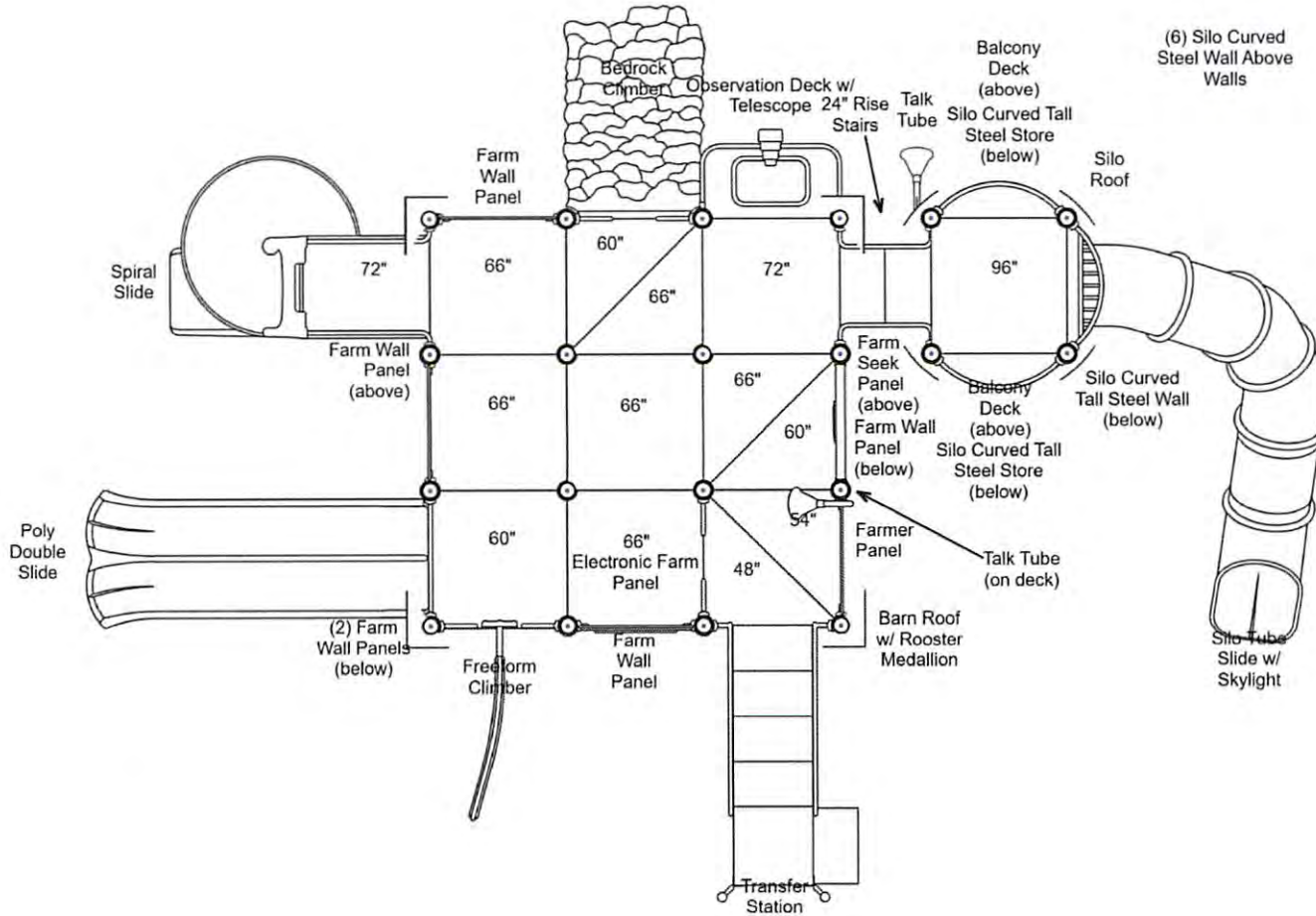

STRUCTURE#: R50A918EA

PROJECT#:

DATE: 6/26/2018 | DRAWN BY: NLH

MIN. USE ZONE: 46' x 37'

PLAYCRAFT REP:

Commercial Recreation Specialis

SITE PLAN

ADA ACCESSIBILITY GUIDELINE - ADAAG CONFORMANCE

ELEVATED	ACCESSIBLE	RAMP ACCESSIBLE	GROUND	TYPES
9	9/5	0	4/3	3/3



**FOR KIDS
AGES
2-12**

GENERAL NOTES:

This Preliminary Site Plan is based on measurements that were provided in the initial planning phase. All dimensions must be verified prior to the submission of a purchase order. Playcraft Systems will not be held responsible for any discrepancies between actual dimensions and dimensions submitted in the planning phase.

The Minimum Use Zone for a play structure is based on the product design at the time of proposal. Components and structure designs may be subject to change which may affect dimensions. Therefore, before preparing the site, we strongly recommend obtaining final drawings from the factory (available after the order is placed and included in the Assembly Manual).

WARNING: Accessible safety surfacing material is required beneath and around this equipment that has a critical height value (Fall Height) appropriate for the highest accessible part of this equipment. Refer to the CPSC'S Handbook For Public Playground Safety, Section 4: Surfacing.

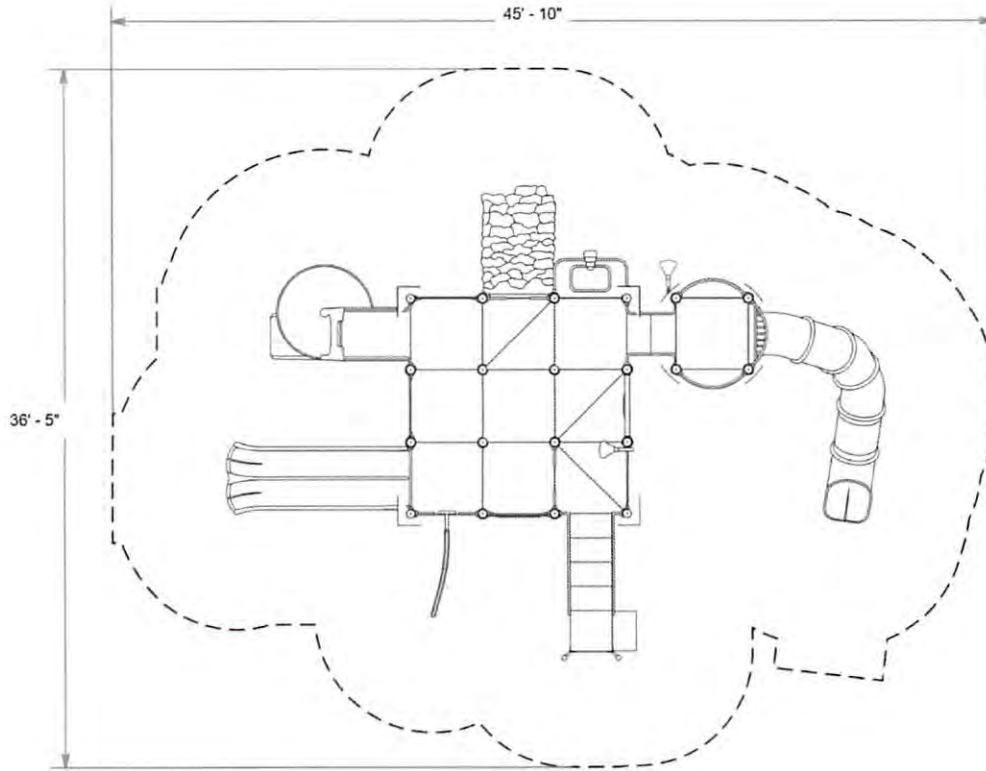

PROJECT#:
 DATE: 6/26/2018 | DRAWN BY: NLH

MIN. USE ZONE: 46' x 37'

PLAYCRAFT REP:
 Commercial Recreation Specialis

SW VIEW

FOR KIDS
AGES
2-12

R5

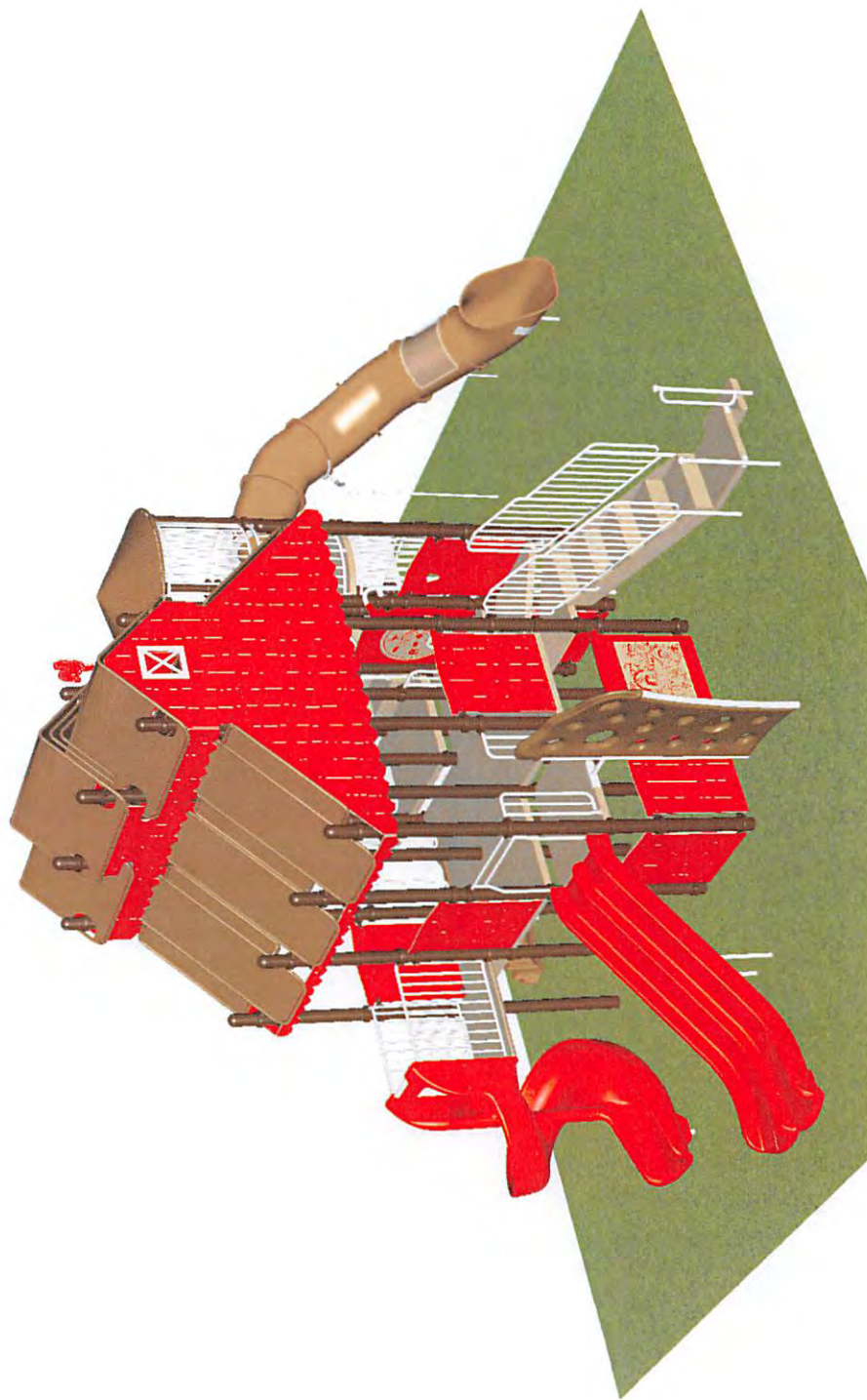

STRUCTURE#: R50A918EA

PROJECT#:

DATE: 6/26/2018

| DRAWN BY: NLH

SE VIEW

FOR KIDS
AGES
2-12

R5

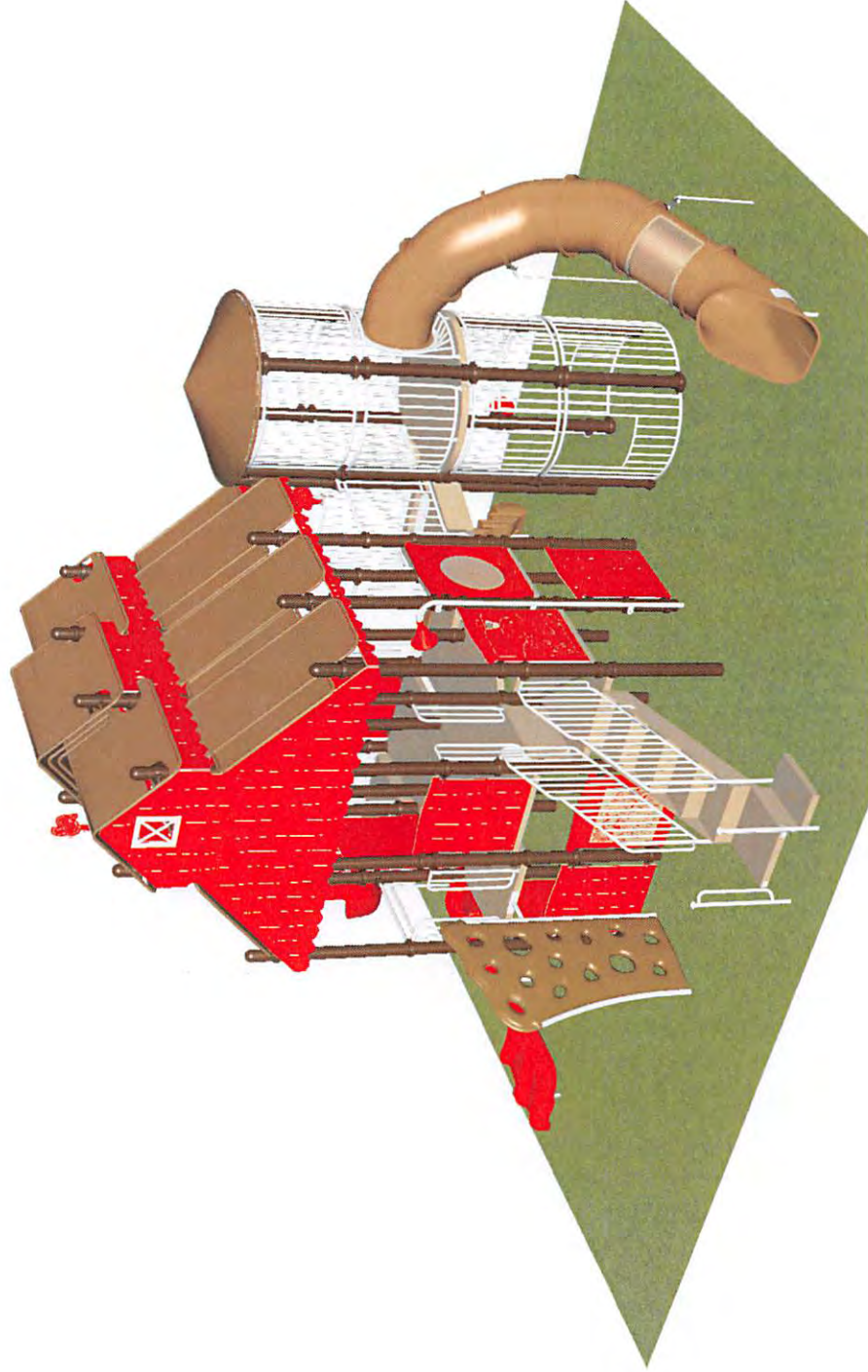

STRUCTURE#: R50A918EA

PROJECT#:

DATE: 6/26/2018 | DRAWN BY: NLH

NE VIEW

FOR KIDS
AGES
2-12

R5

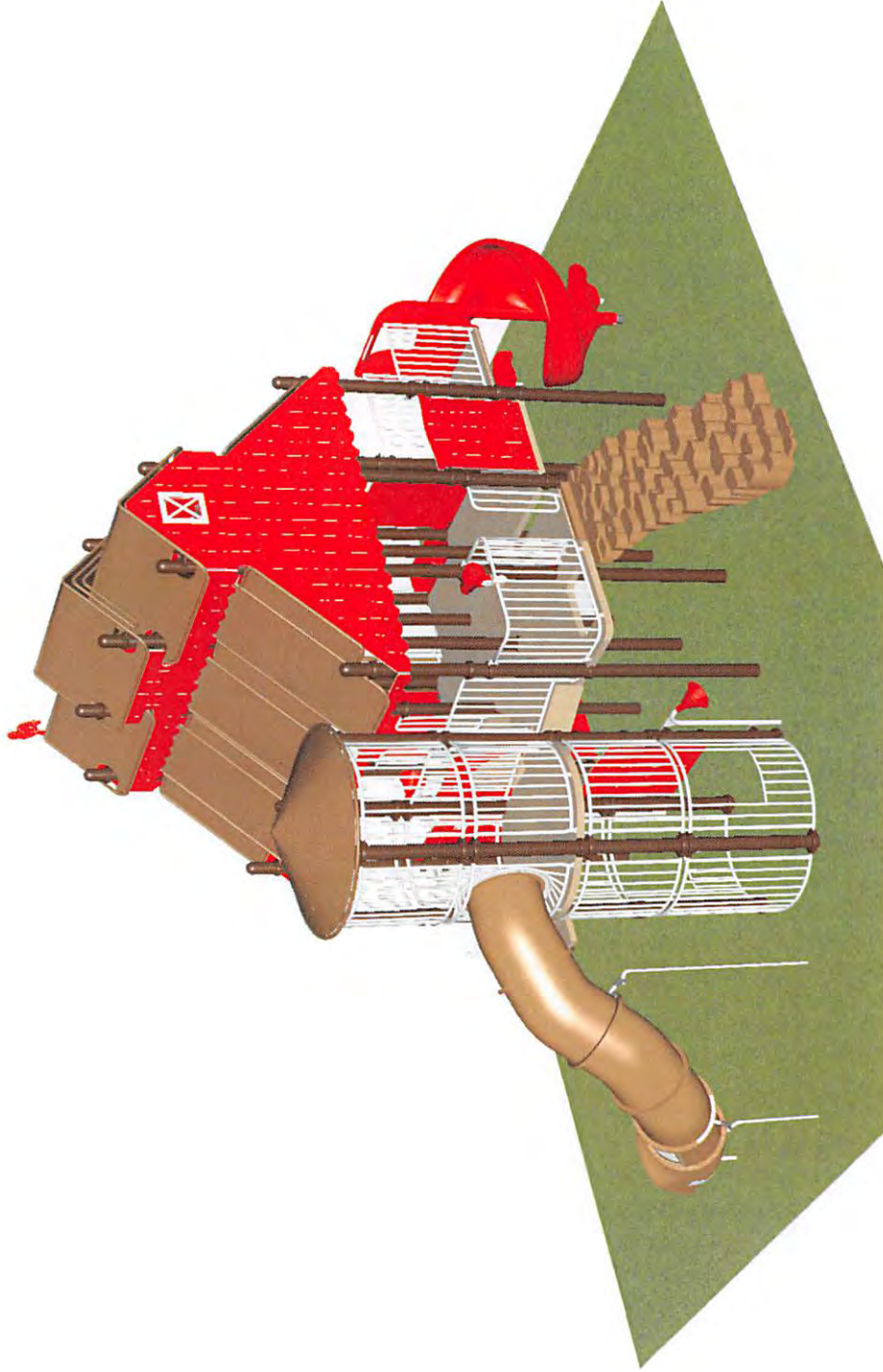

STRUCTURE#: R50A918EA

PROJECT#:

DATE: 6/26/2018 | DRAWN BY: NLH

NW VIEW

FOR KIDS
AGES
2-12

R5

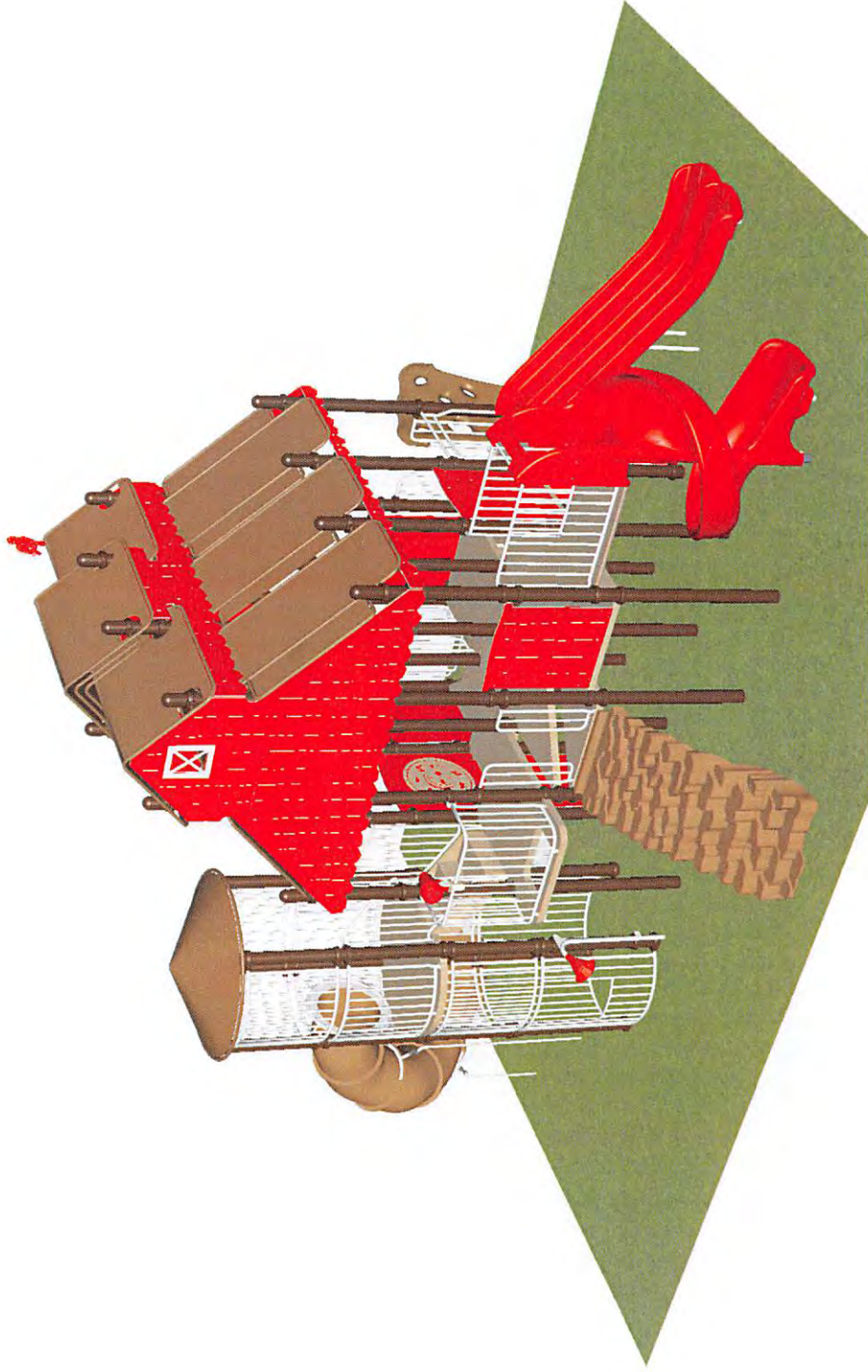

STRUCTURE#: R50A918EA

PROJECT#:

DATE: 6/26/2018 | DRAWN BY: NLH

Pattie Salter

From: Karin Henning <khenning@newspubinc.com>
Sent: Wednesday, July 10, 2019 11:29 AM
To: Pattie Salter
Subject: Ad Price request
Attachments: Town of New Glarus 2x6.pdf

Pattie, Thanks for speaking with me today about your ad.

My recommendation for is to run your ad at least 2 times. Our lead designer created the ad below as an example. It is 2 column wide (3.306") x 6" high for the discounted price of \$115/week.

Our deadline is Thursday's at 2:00 for the next weeks publications. Let me know what your committee decides to move forward with. Thank you, Karin

Karin Henning
News Publishing, Inc.
608-358-7958
khenning@newspubinc.com

On Jul 9, 2019, at 4:35 PM, Karin Henning <khenning@newspubinc.com> wrote:

Pattie, Thank you for sending your ad. If we run the ad using a similar format the cost for a black/white ad that measures 5.042" x 9" would be: \$297 for one week in the PMR paper and the Buyer's Guide. Can you provide us with the actual size photos? We will reset the text so it works at this size and use only one of the decorative headers.

If you would like the ad to be larger than this let me know and I can price out the next size up.

Feel free to contact me with questions. Thank you, Karin

Karin Henning
News Publishing, Inc.
608-358-7958
khenning@newspubinc.com

On Jul 9, 2019, at 4:15 PM, Pattie Salter <psalter@townofnewglarus.com> wrote:



CALLING ALL NEW GLARUS TOWNSHIP RESIDENTS!

**Get paid to help us shape our
recreational and open spaces.**

Work with a team to decide what your Town looks like and all that it offers for recreational opportunities. The mission of the Town's Park Commission is to "assure the needs and desires for recreational opportunities and preservation of natural areas are met." Our committee members meet for two hours a month and are paid \$35 for every meeting they attend.

The Commission has worked on the following projects and more:

- Organizes annual Spring Tree Sale
- Engages in ongoing planning for recreational trails.
- Established and maintains the Blue Bird Ridge Conservancy.
- Hosts annual workshops,
including Bees and Beginning
Beekeeping, Barn Preservation,
Controlling Invasive Species, Bird
Watching and Bats.
- Continually updates the Parks
Plan and Trout Stream Map.
- Provides Arbor Day tree plant-
ing financial support and helping
hands to the Village Forester.
- Holds semi-annual joint meet-
ings with the Village of New Glarus
Parks Committee.



***Bees and Beekeeping
Workshop***

With all those accomplishments already, what is this group planning for the future? **The commission would like to build its membership in 2019.** If you reside in the Town of New Glarus please contact the Clerk-Treasurer, Pattie Salter, 608-527-2390 or psalter@townofnewglarus.com or Chair, Harry Pulliam, 527-3325 to find out more. The commission meets the third Wednesday of the month at 7:00 pm at the Town Hall, 26 5th Avenue.



CALLING ALL NEW GLARUS TOWNSHIP RESIDENTS!

Get paid to help us shape our recreational and open spaces.

Work with a team to decide what your Town looks like and all that it offers for recreational opportunities. The mission of the Town's Park Commission is to "assure the needs and desires for recreational opportunities and preservation of natural areas are met." Our committee members meet for two hours a month and are paid \$35 for every meeting they attend.

The Commission has worked on the following projects and more:

- Organizes annual Spring Tree Sale
- Engages in ongoing planning for recreational trails.
- Established and maintains the Blue Bird Ridge Conservancy.
- Hosts annual workshops, including Bees and Beginning Beekeeping, Barn Preservation, Controlling Invasive Species, Bird Watching and Bats.
- Continually updates the Parks Plan and Trout Stream Map.
- Provides Arbor Day tree planting financial support and helping hands to the Village Forester.
- Holds semi-annual joint meetings with the Village of New Glarus Parks Committee.



***Bees and Beekeeping
Workshop***

With all those accomplishments already, what is this group planning for the future? **The commission would like to build its membership in 2019.** If you reside in the Town of New Glarus please contact the Clerk-Treasurer, Pattie Salter, 608-527-2390 or psalter@townofnewglarus.com or Chair, Harry Pulliam, 527-3325 to find out more. The commission meets the third Wednesday of the month at 7:00 pm at the Town Hall, 26 5th Avenue.